

RV118U

REVERE GRANITE

Revere Granite sinks come in six colors to match any countertop: beige, black, mocha, silver, slate, and white. Molded from 80% quartz and 20% acrylic, these sinks are naturally soundproof, scratch and stain-resistant, and can withstand temperatures up to 550 degrees.



ACCESSORIES

- Basket Strainer:** S2
- Colored Strainer:** S3
- Colored Flange:** S4
- Large Grid:** GL-118
- Small Grid:** GS-118

*Accessories not included

AVAILABLE COLORS





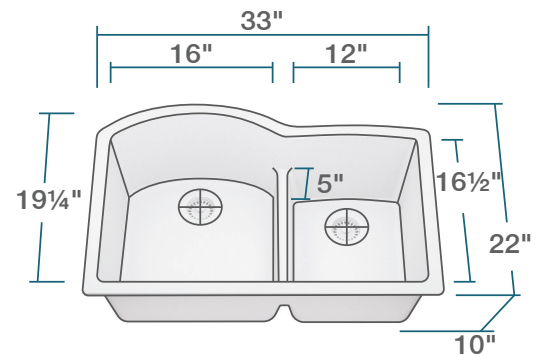



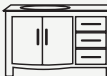

Undermount Installation
 80% Quartz and 20% Acrylic
 All-Natural Materials
 Eco Friendly & Recyclable
 3 1/2" Offset Drains
 Naturally Sound-Dampening
 Cardboard Cutout Template Included
 Installation Hardware Included
 Lifetime Warranty



Full Pallet Quantity: 26

FEATURES

Undermount Installation 	33" Minimum Cabinet Size 	80% Quartz 20% Acrylic 	Installation Hardware Included 	Cutout Template 	Offset Drain 3 1/2" 
Limited Lifetime Warranty 	Heat Resistant to 550° 	Stain Resistant 	Scratch Resistant 		



REVERE
 The Rock Solid Choice